

Grease Guns

Hand Grease Guns

YAMADA is offering high quality, high performance and durable hand grease guns.

Select the best model for your needs depending on size, capacity, grease loading method, etc.

All grease guns are equipped with straight steel extension or 3-jaw steel extension as standard.

854655 KH-16



- Compact size pistol type grease gun with 3-jaw steel extension (CNP-2)
- Barrel with lipped follower for use with 140mL direct-filling or 85mL Bellows Cartridge



854629 KH-120



- Compact size light-weight grease gun with straight steel extension
- Barrel with lipped follower for use with 140mL direct-filling or 85mL Bellows Cartridge

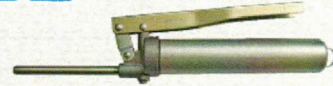

854628 KH-32



- Small size grease gun with straight steel extension
- Barrel with lipped follower for use with 200mL direct-filling

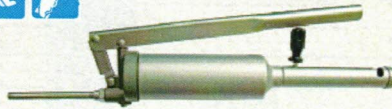

854627 KH-35



- Medium size hand grease gun with straight steel extension
- Barrel with lipped follower for use with 400mL direct-filling or 210mL Bellows Cartridge



854669 CH-400EX



- Standard size grease gun with 3-jaw steel extension (CNP-2)
- Barrel with lipped follower for use with 500mL direct-filling or 420mL Bellows Cartridge

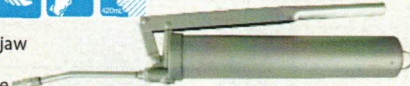

854787 CH-650LL



- Standard size high-pressure grease gun with 3-jaw steel extension (CNP-1)
- Ergonomic rubber grip on lever handle for comfortable use
- Barrel with lipped follower for use with 500mL direct-filling or 420mL Bellows Cartridge



854654 GC-57K



- Standard size grease gun with 3-jaw steel extension (CNP-2)
- Barrel with lipped follower for use with 500mL direct-filling or 400g DIN1284 Cartridge

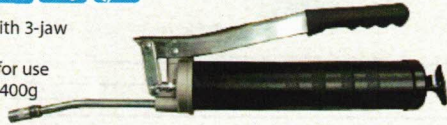

Specifications

Model No.	Model	Length* (mm)	Extension	Weight* (kg)	Barrel Dia. (mm)	Barrel Capacity (mL)	Cartridge (mL)	Discharge per Stroke (mL)	Max Discharge Pressure (MPa)
854655	KH-16	241	CNP-2	0.44	38.0	140	85	0.4	10
854629	KH-120	232	HSP-1	0.51	38.0	140	85	0.6	20
854627	KH-35	290	HSP-1	1.11	59.6	400	210	1.0	25
854628	KH-32	412	HSP-1	1.27	59.6	200	---	1.6	25
854669	CH-400EX	368	CNP-2	1.30	59.6	550	420	1.0	50
854787	CH-650LL	401	CNP-1	1.30	59.6	550	420	1.0	80
854654	GC-57K	371	CNP-2	1.55	57	500	DIN 1284 (400g)	1.0	50

*Extension is not included

Dimensions

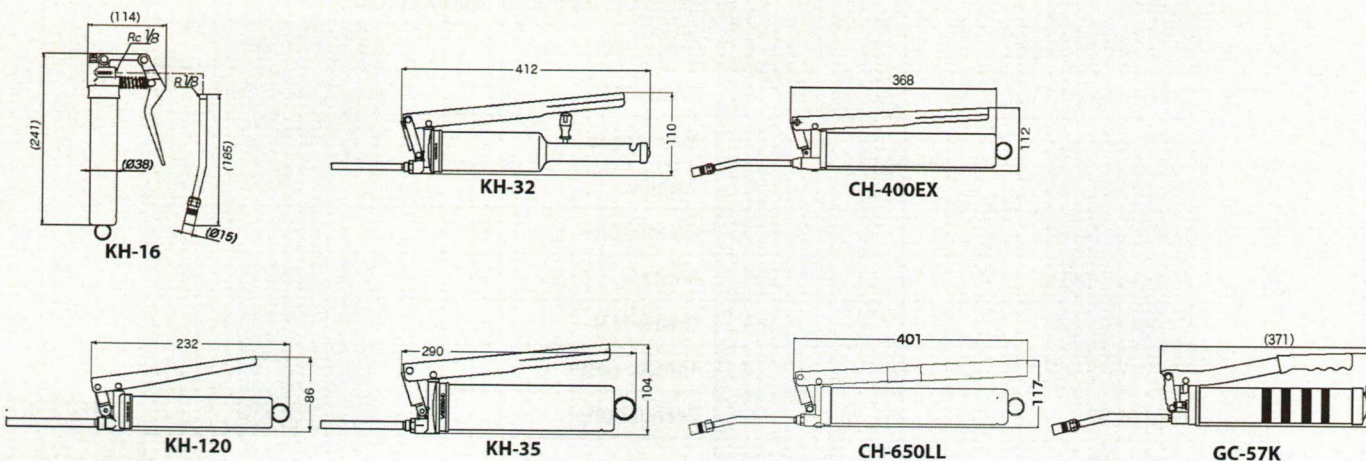

Electric Driven Grease Guns

AC100V electric and DC24V battery operated hand held grease guns.
All models are only available with 420mL Bellows Cartridge.



852443 EG-400A



852441 EG-400D



852216 EG-400B

Specifications

Model No.	Model	Cartridge (mL)	Extension	Max Discharge Pressure (MPa)	Discharge Volume	Power Source	Power Rating (W)	Weight (kg)
852443	EG-400A	420	CNP-1	40	1.6mL/sec or above at 6MPa load	AC100V	240	2.7
852441	EG-400D			32	1.6mL/sec or above at 6MPa load	DC24V	430	2.7
852216	EG-400B*1			32	1.6mL/sec at 6MPa load	2.0mL/sec at 0.5MPa load	DC9.6V	---

*1 Battery Charger EG-1414-Y and Battery EG-9002-Y is equipped as standard

*2 Exclude battery

Battery Charger Specifications

Model No.	Model	Power Source	Frequency (Hz)	Capacity (VA)	Voltage (V)	Current (A)	Charging Time
684741	EG-1414-Y	AC100V	50/60	105	DC7.2-14.4	DC2.6	Approx 45 min.

Optional Accessories

Model No.	Model	Description	Fits model
802039	BC-165D	Extension Power Cord 15M	EG-400D
684741	EG-1414-Y	Battery Charger (AC100V)	EG-400B
683877	EG-9002-Y	Battery	EG-400B

Dimensions

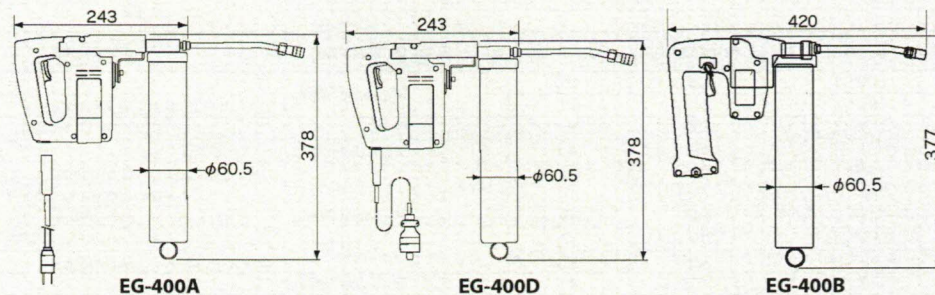

Air Operated Grease Guns

Grease flows continuously with press of the trigger.
Only available with 420mL Bellows Cartridge.



854884 AMG-400N

Dimensions

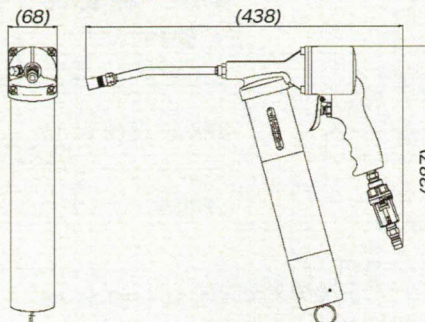

Battery Charger Specifications

Model No.	Model	Cartridge (mL)	Extension	Max Discharge Pressure (MPa)	Max Discharge Volume (mL/min)	Supply Air Pressure (MPa)	Weight (kg)
854884	AMG-400N	420	CNP-2	32	280	0.3-0.7	1.8



Digital Grease meter

Model No.	Model	Fits model
805195	GM-200	EG-400series, AMG-400, SKR series etc.



Extensions

Optional steel and flexible extensions for grease fittings are available. These can fit to all Hand Grease Guns.

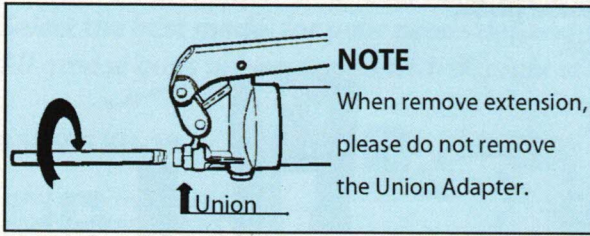

Grease Fittings JIS B 1575



Hydraulic Fitting
Most common fitting.



Pin Type Fitting

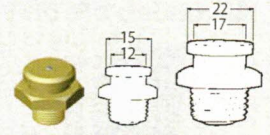

Button Head Fitting
Normal size and large size are available

804903 HSP-1

804904 HSP-2

800701 HSP-3

804907 HSP-10

851268 SPK-700E

850478 SPK-1C-1M

804910 CNP-1

804911 CNP-2

804912 CNP-13

686445 CNP-1H

686446 CNP-2H

850664 SPK-1C

850665 SPK-2C

850666 SPK-3C

850392 SPK-5

850381 SPK-20C

850479 SPK-2C-1M

850480 SPK-3C-1M

Specifications

Type	Model No.	Model	Length(mm)	Weight(g)	Usable Grease Fitting	Remark
Straight Steel Extension	804903	HSP-1	120	46	Hydraulic Fitting	Nozzle O.D. 1.5mm
	804904	HSP-2	240	96		
	800701	HSP-3	135	56		
	804907	HSP-10	450	188		
Steel Extension with 3-jaw Coupler	804910	CNP-1	185	93	Hydraulic Fitting	O.D. 17mm
	686445	CNP-1H	38.5	37		3-jaw Coupler for CNP-1
	804911	CNP-2	185	93		O.D. 15mm
	686446	CNP-2H	39	37		3-jaw Coupler for CNP-2
	804912	CNP-13	335	180		O.D. 15mm
Flexible Extension with 3-jaw Coupler	850664	SPK-1C	355	141	Pin Type Fitting	
	850665	SPK-2C	375	180	Button Head Fitting	
	850666	SPK-3C	330	83	Hydraulic Fitting	
	850478	SPK-1C-1M	1069	189	Pin Type Fitting	
Normal Operating Pressure: 21MPa	850479	SPK-2C-1M	1070	242	Button Head Fitting	
	850480	SPK-3C-1M	1030	132	Hydraulic Fitting	
	850392	SPK-5	418	300	Hydraulic Fitting	Extension for CNP Series
	850381	SPK-20C	377	320	Large size Button Head Fitting	
	851268	SPK-700E	705	160	Hydraulic Fitting	

Dimensions

HSP-1 HSP-2
HSP-10

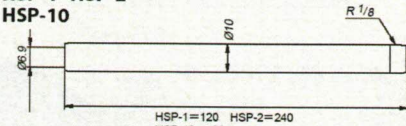

HSP-3

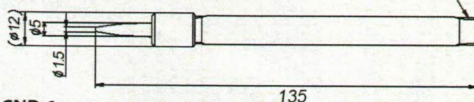

CNP-1

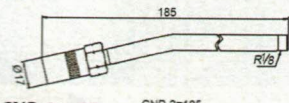

CNP-1H

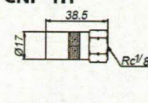

CNP-2 · 13

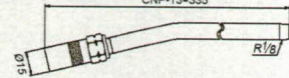

CNP-2H

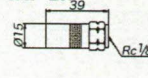

SPK-1C · SPK-1C-1M

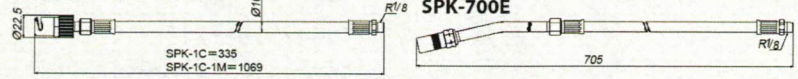

SPK-700E

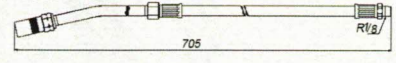

SPK-2C · SPK-2C-1M

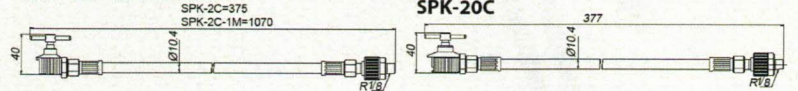

SPK-20C

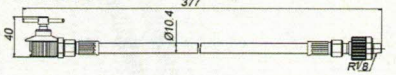

SPK-3C · SPK-3C-1M

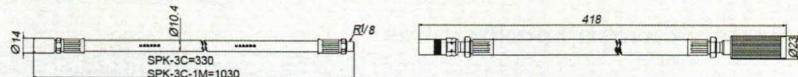

SPK-5

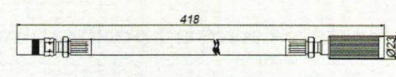

Bellows Cartridge Greases

YAMADA Bellows Cartridge Grease is reputed as clean, convenient and economical cartridge grease, which is long-selling product in Japan.

With the tightly-sealed bellows, contamination and air-pocket can be eliminated.

By the screw cap, the cartridge change is possible in the middle of use.

General Purpose Greases

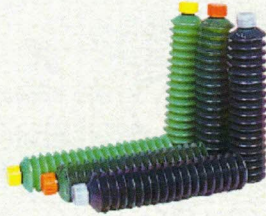

MMG-80 Series

Dimensions

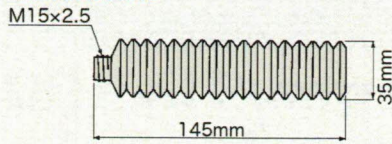

MMG-200 Series

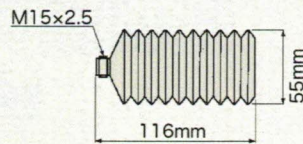

MMG-400 Series

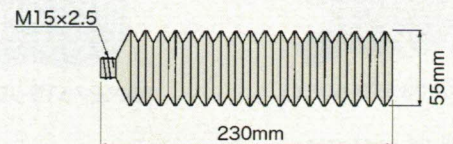

Specifications

Capacity, Qty per Carton Box	Model No.	Model	Grease Type	NLGI No.	ASTM Value	Temp Range	Fits model
420mL, 20pcs	682314	MMG-400MP	Lithium	No.2	265-295	-15°C - 130°C	KH-500, CH-400, CH-650LL, EG-400A, EG-400D, EG-400B, AMG-400
	682313	MMG-400CG	Chassis	No.1	310-340	-10°C - 80°C	
	682312	MMG-400MO	Molybdenum	No.2	265-295	-15°C - 150°C	
210mL, 20pcs	683311	MMG-200MP	Lithium	No.2	265-295	-15°C - 130°C	KH-35
	683312	MMG-200CG	Chassis	No.1	310-340	-10°C - 80°C	
	683313	MMG-200MO	Molybdenum	No.2	265-295	-15°C - 150°C	
85mL, 30pcs	682593	MMG-80MP	Lithium	No.2	265-295	-15°C - 130°C	KH-16, KH-120
	683309	MMG-80CG	Chassis	No.1	310-340	-10°C - 80°C	
	683310	MMG-80MO	Molybdenum	No.2	265-295	-15°C - 150°C	

Grease Characteristics

Grease Type	Features	Applications	Color of Cap	Color of Bellows
Lithium Grease (MP)	Extreme-pressure, Water-resistant, Heat-resistant, High durability	Bearings for industrial equipment, automobiles, construction equipment and conveyor	Yellow	Green
Chassis Grease (CG)	Extreme-pressure, Water-resistant	Chassis of automobiles, construction equipment, conveyor and agricultural equipment	Orange	
Molybdenum Grease (MO)	Molybdenum-added, Extra high-pressure, Extra high-durability	Construction equipment, joints, bearings, the part on which needs high-pressure and heating	White	

High Temp and Food Grade Greases



NPC-AA



FDL-FF20

Dimensions

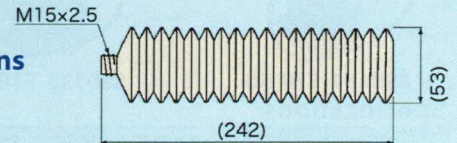

Specifications

Capacity, Qty per Carton Box	Model No.	Model	Grease Type	NLGI No.	ASTM Value	Temp Range	Fits model
420mL, 20pcs	684200	NPC-AA	Urea	No.2	265-295	-20°C-180°C	KH-500, CH-400, CH-650LL, EG-400A, EG-400D, EG-400B, AMG-400
	685800	FDL-FF20	Aluminum Complex	No.2	265-295	-20°C-180°C	
420mL, 5pcs	685801	FDL-FF5					

Grease Characteristics

Grease Type	Features	Applications	Color of Cap	Color of Bellows
Urea Grease (AA)	Extra high-temperature	Equipment for heavy industry, paper industry, cement industry, and any other application that require high heat resistance and long life	White	Green
Aluminum Complex (FF)	Meets the requirements by NSF-H1*	Food industry		White

*NSF: National Sanitation Foundation International

Hand-Operated Oil Pumps

Oil Bucket Pumps EXS Series

Ready-to-assemble economical series.
The small package can reduce shipping cost.

Installation



880626 STB-60EXS

880627 STB-70EXS

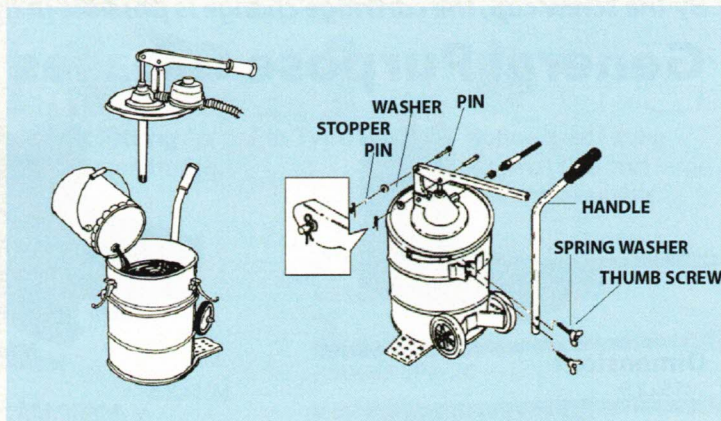

Dimensions

Specifications

Model No.	Model	Capacity (L)	Discharge Volume per Cycle (mL)	Stroke Length (mm)	Weight (kg)	Standard Accessories
880626	STB-60EXS	20	40.0	50.0	10.4	802823 STB-2MW Hose Nozzle Assy 2M (Vynil).....1 805184 OM-30M.....1
880627	STB-70EXS				9.0	802823 STB-2MW Hose Nozzle Assy 2M (Vynil).....1

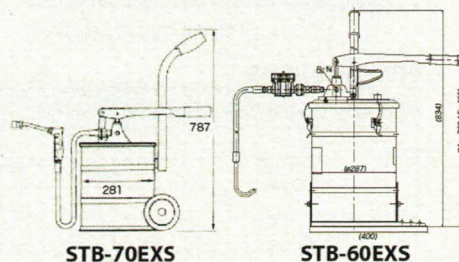

STB-70EXS

STB-60EXS

Oil Bucket Pumps

Please select suitable model depending on by the presence or absence of S-20 Dolly and STB-M Oil Meter.

Installation



880134 STB-50

880135 STB-60

880136 STB-70

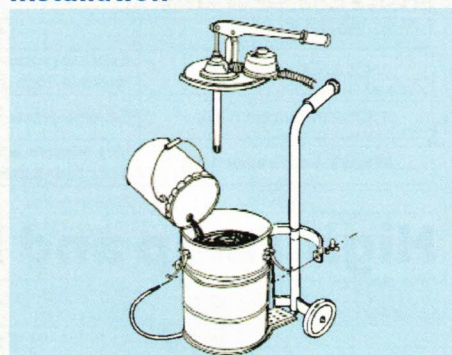

Dimensions

Specifications

Model No.	Model	Capacity (L)	Discharge Volume per Cycle (mL)	Stroke Length (mm)	Weight (kg)	Standard Accessories
880134	STB-50	20	40.0	50.0	7.3	695453 STB-2MB Hose Nozzle Assy 2M (Rubber).....1 851003 S-20 Dolly.....1 805184 OM-30M.....1
880135	STB-60				10.4	695453 STB-2MB Hose Nozzle Assy 2M (Rubber).....1 851003 S-20 Dolly.....1 805184 OM-30M.....1
880136	STB-70				9.2	695453 STB-2MB Hose Nozzle Assy 2M (Rubber).....1 851003 S-20 Dolly.....1

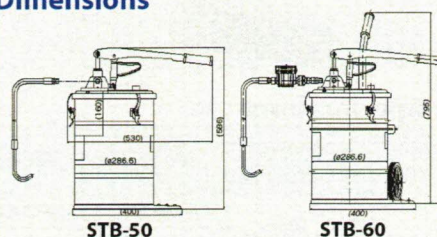

STB-50

STB-60

Optional Accessories

Model No.	Model	Description	Fits Model
851003	S-20	Dolly	STB-50, STB-60, STB-70
805184	OM-30M	Mechanical Oil Meter	STB-50, STB-60, STB-70
805185	OM-30D	Electronic Oil Meter	STB-50, STB-60, STB-70
695453	STB-2MB	Hose Nozzle Assy 2M (Rubber)	STB-50, STB-60, STB-70
802823	STB-2MW	Hose Nozzle Assy 2M (Vynil)	STB-60EXS, STB-70EXS



851003 S-20



805184 OM-30M



805185 OM-30D

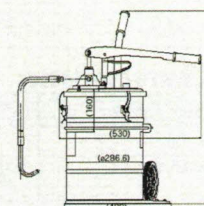

STB-70

Hand Oil Suction Guns

Simple syringe pump for oil.

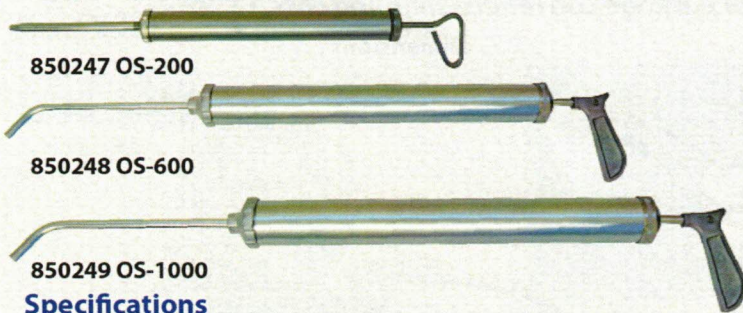

850247 OS-200

850248 OS-600

850249 OS-1000

Specifications

Model No.	Model	Length (mm)	Weight (kg)	Capacity (mL)
850247	OS-200	490	0.57	200
850248	OS-600	696	1.28	600
850249	OS-1000	886	1.77	1000

Dimensions

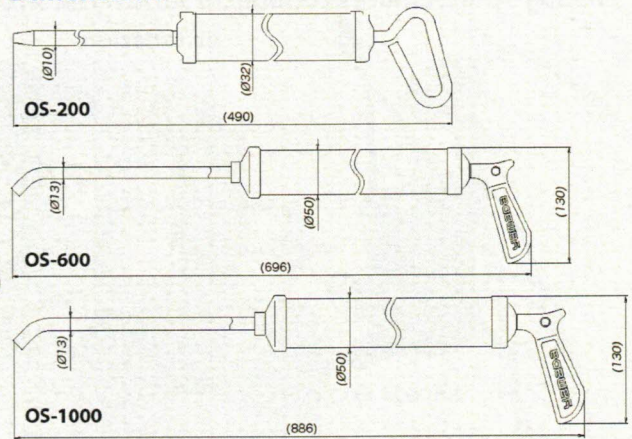

Oil Pail Pump

Simple pump that can be mounted on commercially available 20L pail. Oil meter STB-M can be mounted.



880571 HOP-20

Specifications

Model No.	Model	Discharge Volume per Cycle (mL)	Stroke Length (mm)	Weight (kg)	Standard Accessories
880571	HOP-20	60.0	110.0	1.9	802823 STB-2MW Hose Nozzle Assy 2M (Vynil).....1 851676 S-10N Dolly.....1

Dimensions

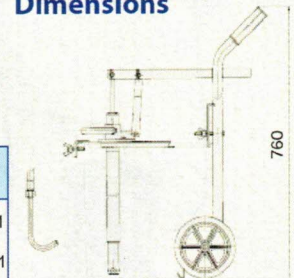

Oval Shape Oil Bucket Pumps

Small size and durable oval shape bucket pump. Suitable for field lubrication work.



880318 LPO-50

Specifications

Model No.	Model	Discharge Volume per Cycle (mL)	Weight (kg)	Standard Accessories
880318	LPO-50	40.0	8.8	802823 STB-2MW Hose Nozzle Assy 2M (Vynil).....1

Dimensions

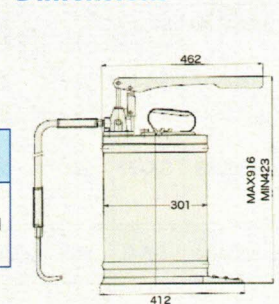

High Viscosity Oil Pumps



880132 VO-8
Compact size bucket pump

880133 VO-50
Small size oval shape bucket pump

Specifications

Model No.	Model	Discharge Volume per Cycle (mL)	Weight (kg)	Standard Accessories
880132	VO-8	20.0	5.0	695056 VO8-1M 1/4 x 1m Hose.....1 800772 VO8-15 Button Head Coupler.....1
880133	VO-50	24.0	9.6	695055 VO50-1.5M 3/8 x 1.5m Hose.....1 800894 VO50-15 Button Head Coupler.....1

Dimensions

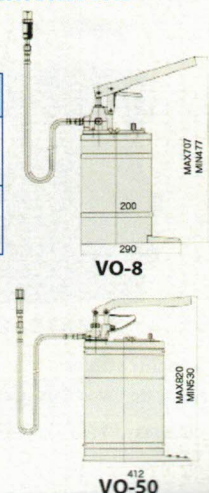

Optional Accessories

800772 VO08-15

Button Head Coupler for VO-8



800894 VO50-15

Normal Size Button Head Coupler for VO-50



800628 VO50-22

Large Size Button Head Coupler for VO-50



Hand/Foot-Operated Grease Pumps

Grease Bucket Pump EXS Series



Ready-to-assemble economical series. The small package can reduce shipping cost.



880624 SK-77EXS

Installation

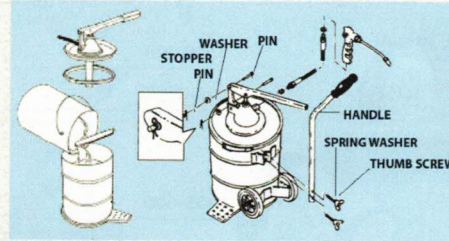

Dimensions

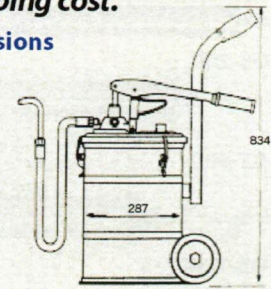

Specifications

Model No.	Model	Capacity (L)	Discharge Pressure (MPa)	Discharge Volume per Stroke (g)	Stroke Length (mm)	Weight (kg)	Standard Accessories
880624	SK-77EXS	20	25.0	3.2	38-43	9.6	800601 SK-G Grease Nozzle.....1 695046 SK-2M Grease Hose 2M.....1

Grease Bucket Pump



Follow plate is equipped with SK-55 and SK-77 as standard. Compact SK-8 is suitable for filed lubrication work.



880307 SK-55

880308 SK-77

880194 SK-8

Installation

When refilling the standard grease container. When fitting to other kinds of grease pail (except SK-8 and HPG-50).

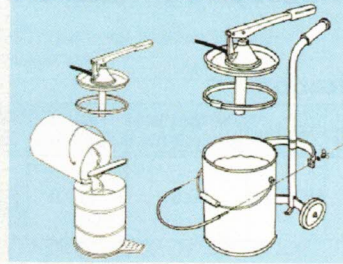

Dimensions

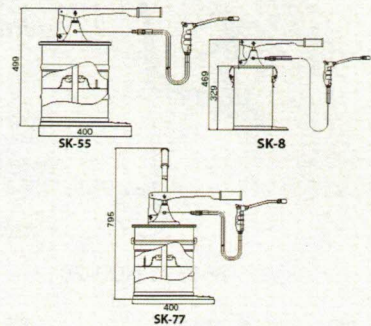

Specifications

Model No.	Model	Capacity (L)	Discharge Pressure (MPa)	Stroke Length (mm)	Weight (kg)	Standard Accessories
880307	SK-55	20	25.0	50.0	8.7	800601 SK-G Grease Nozzle.....1 695046 SK-2M Grease Hose 2M.....1 801426 Follower Plate.....1
880308	SK-77	20	25.0	50.0	11.3	800601 SK-G Grease Nozzle.....1 695046 SK-2M Grease Hose 2M.....1 801426 Follower Plate.....1 851003 S-20 Dolly.....1
880194	SK-8	10	25.0	—	6	800601 SK-G Grease Nozzle.....1 695046 SK-2M Grease Hose 2M.....1



851003 S-20



Replacement Hoses

Optional Accessories

Model No.	Model	Description	Fits Model
851003	S-20	Dolly	SK-55, SK-77
695046	SK-2M	Grease Hose 2M Max 18MPa	SK-55, SK-77, SK-77EXS, SK-8
695100	SK-3M	Grease Hose 3M Max 18MPa	SK-55, SK-77, SK-77EXS, SK-8
695102	SK-5M	Grease Hose 5M Max 18MPa	SK-55, SK-77, SK-77EXS, SK-8

Foot Operated Grease Pump

Hands-free, waste free and mess free greasing!



686833 FB-8

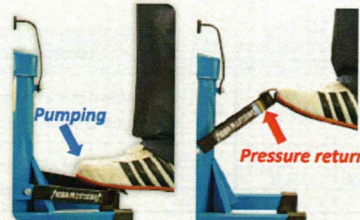

All the pressure in the hose is released into the bucket by hooking up the foot pedal.

Specifications

Model No.	Model	Capacity	Discharge/stroke	Discharge press	Hose	Dimensions(mm)	Weight
686833	FB-8	8L	2.7mL	69MPa	1/4"×2M	L450×W239×H452	8.6kg

Grease Lock Coupler

Easy coupling - Leak proof greasing - Easy release!



686830 GLC-70

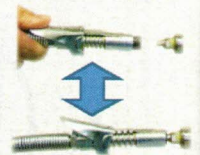

Easy connect and disconnect to/from grease fitting, by operating the lever.

Specifications

Model No.	Model	Operating pressure	Connection	Dimensions(mm)	Weight
686830	GLC-70	69MPa	Rc1/8"	L89.6×Φ16	100g
686966	GLC-70L	69MPa	Rc1/8"	L137.3×Φ16	160g

Micro® hose type

Model No.	Model	Specifications
805177	SPK-500S	500mm(Micro® hose connection R1/8")
805178	SPK-1000S	1000mm(Micro® hose connection R1/8")
805252	SPK-1500S	1500mm(Micro® hose connection R1/8")



SPK-500S/1000S/1500S

Air-Operated Oil Lubricators

Standard SGR-55 and high volume, high pressure SGR110A5 are available. SGR110A5 is equipped with float-type oil level gauge and mechanical oil flow meter with non-drip flexible extension as a standard.



880267 SGR-55



880635 SGR110A5

Dimensions

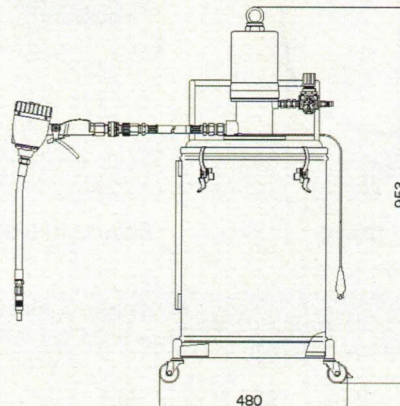
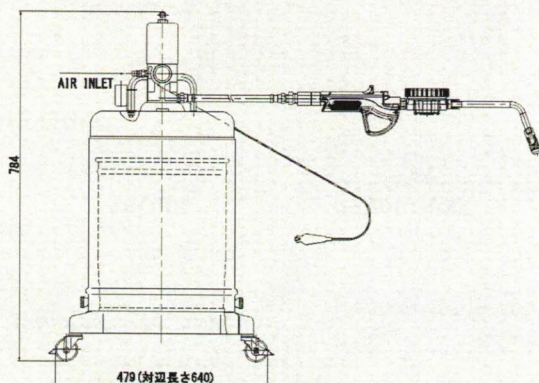

Specifications

Model No.	Model	Capacity (L)	Pump Ratio	Max Discharge Pressure (MPa)	Max Discharge Volume (L/min)	Max Air Consumption (NL/min)	Weight (kg)	Standard Accessories
880267	SGR-55	20 (Attached pail can)	1.8 : 1	1.2	7.0	200	17.0	850792 SGR-55PA Oil Transfer Pump.....1 686858 Electric oil control gun.....1 695052 SGR-55-1.5M Oil Hose 1.5M.....1 682905 Pail Can.....1 680743 PS-20PM Air Coupler Plug.....1
880635	SGR110A5	50	5:1	3.5	11.0	630	27.5	851755 PD110A5 Oil Transfer Pump.....1 801428 LBM-G Lube Mechanical Meter.....1 805161 NDN-H-3 Flexible Hose Extension.....1 804553 OIL-SJ Swivel Joint.....1 695700 110H-3M Oil Hose 3M.....1 802553 AR-110A Air Regulator w/ Air Plug.....1

Optional Accessories

Model No.	Model	Description	Fits Model
695052	SGR-55-1.5M	Oil Hose 1.5M Max 7MPa	SGR-55
695051	SGR-55-2M	Oil Hose 2M Max 7MPa	SGR-55
695103	SGR-55-3M	Oil Hose 3M Max 7MPa	SGR-55
695154	SGR-55-5M	Oil Hose 5M Max 7MPa	SGR-55
695866	110H-1M	Oil Hose 1M Max 7MPa	SGR110A5
695092	110H-2M	Oil Hose 2M Max 7MPa	SGR110A5
695700	110H-3M	Oil Hose 3M Max 7MPa	SGR110A5
695156	110H-5M	Oil Hose 5M Max 7MPa	SGR110A5



Replacement Hoses